



autologous cultured
chondrocytes
on porcine
collagen membrane

REHABILITATION MANUAL

Guidelines for the functional recovery of
patients following MACI for the treatment
of cartilage defects of the knee

Written by:

Jay Ebert, PhD, AEP ESSAM
Hollywood Functional Rehabilitation Clinic
School of Sport Science, Exercise and Health
University of Western Australia



Please see Important Safety Information on page 21 and accompanying [full Prescribing Information](#)



INTRODUCTION

The purpose of this manual is to provide guidance for the development of a physician-prescribed rehabilitation program to foster early mobilization and load protection, promote graft maturation, and reduce the risk of graft delamination, postoperative thromboembolic events, and joint stiffness.

The MACI® (autologous cultured chondrocytes on porcine collagen membrane) Rehabilitation Manual is based on clinical experience* that supports the use of a controlled rehabilitation program to promote a progressive return to full range of motion (ROM) and weight bearing (WB), as well as muscle strengthening and conditioning. The rehabilitation program was designed using the knowledge of basic science, anatomy, and the biomechanics of articular cartilage, as well as the natural course of healing following implantation. It is not intended as a substitute for individual clinical judgment, and a patient-specific rehabilitation program should be implemented.

The goal is to restore optimal function in each patient as quickly and safely as possible. Although timeframes have been established as a guide, **it is more important that goals are reached at the end of each phase prior to progression to the next.**

*Ebert JR, Fallon M, Robertson WB, Lloyd DG, Zheng MH, Wood DJ, Ackland T.

KEY POINTS OF CONSIDERATION

- Patient adherence to the prescribed rehabilitation program is critical.
- Consider lesion size, location and patient characteristics when determining a rehabilitation program.
- Emphasis should be placed on reaching the goals of a given phase over rigid adherence to time schedule.
- It is important to avoid excessive load/WB on the graft site to allow proper healing.
- Pain and swelling must be carefully monitored throughout the rehabilitation process. Ignoring these symptoms may compromise the success of the surgery and the patient's outcome.
- If sharp pain with locking or swelling is experienced, the patient should notify their surgeon immediately. Activity should be adjusted to lessen the irritation. Cryotherapy may be used to control the swelling.

MACI REHABILITATION MATURATION PHASES*

	REHABILITATION PHASE	FOLLOWING SURGERY	STAGE OF TISSUE DEVELOPMENT
1	IMMEDIATE POST-OP	0-1 week	Implantation and Protection Cells adhere to bone and begin to proliferate throughout the defect
2	RESTORE MOBILITY	2-3 weeks	
3	STRENGTHEN & STRAIGHTEN	4-6 weeks	
4	INDEPENDENT MOVEMENT	7-12 weeks	Transition and Proliferation Continued proliferation forms a defect-spanning matrix
5	RETURN TO DAILY ACTIVITY	3-6 months	Remodeling Expansion of the cell matrix into putty-like consistency
6	RECREATIONAL ACTIVITIES	6-9 months	
7	RETURN TO FULL ACTIVITY	9-12 months	Maturation Progressive hardening until a durable repair tissue is formed

*Based on clinical observations. Individual results for timeline and repair tissue progress will vary.

MACI POST-OPERATIVE REHABILITATION TIMELINE*

*Based on clinical observations. Individual results for timeline and repair tissue progress will vary.

	1 IMMEDIATE POST-OP 0-1 week following surgery		2 RESTORE MOBILITY 2-3 weeks following surgery		3 STRENGTHEN & STRAIGHTEN 4-6 weeks following surgery	
	Tibiofemoral joint	Patellofemoral joint	Tibiofemoral joint	Patellofemoral joint	Tibiofemoral joint	Patellofemoral joint
Weight bearing (WB) % of body weight	<20%	<20%	Progress from <20%–30%	Progress from <20%–50%	Progress from <40%–60%	Progress from 75%–full
Range of motion (ROM)	Passive and active, progress from 0°–30°	Passive and active, progress from 0°–20°	Active, progress from 30°–90°	Active, progress from 30°–60°	Active, progress from 110°–125°	Active, progress from 90°–125°
Protective knee bracing	Progress from 0°–30°	Locked at full knee extension	Progress from 30°–45°	Locked at full knee extension	Progress from 45°–full extension	Use brace as required (beginning Week 6)
Ambulatory aids	2 crutches	2 crutches	2 crutches	2 crutches	1-2 crutches	1-2 crutches (Weeks 4-5); 1 crutch as required (Week 6)

The MACI Post-Operative Rehabilitation Timeline outlines the importance of a progressive rehabilitation protocol. It stresses the importance of a tailored approach to each individual's rehabilitation that will protect the graft while stimulating the cells to promote optimal maturation. Mechanical loading is an important regulator of chondrocyte differentiation. Key types of loading include cyclic compressive loading (enhances chondrogenesis); shear loading (increases matrix production and improves biomechanical structure); and excessive WB (which can be detrimental to development and repair of cartilage).

4		5		6		7	
INDEPENDENT MOVEMENT		RETURN TO DAILY ACTIVITY		RECREATIONAL ACTIVITIES		RETURN TO FULL ACTIVITY	
7-12 weeks following surgery		3-6 months following surgery		6-9 months following surgery		9-12 months following surgery	
Tibiofemoral joint	Patellofemoral joint	Tibiofemoral joint	Patellofemoral joint	Tibiofemoral joint	Patellofemoral joint	Tibiofemoral joint	Patellofemoral joint
Progress from 80%–full (Weeks 8-10)	Full	Full	Full	Full WB and ROM		Full WB and ROM	
Active, full (Weeks 7-8)	Active, full (Weeks 7-8)	Full and pain-free active ROM	Full and pain-free active ROM	Ability to tolerate walking distances of more than 3 miles		Ability to commence a running program	
Allow full knee flexion within brace	No brace	No brace	No brace	Ability to effectively negotiate uneven ground, including soft sand		Resumption of dynamic recreational activities (activities that generate high compression, shear and rotational loads are to be avoided until 12-18 months or as directed by the orthopedic surgeon)	
Full WB indoors, single crutch outdoors and in unfamiliar areas	No crutches	No crutches	No crutches	Ability to return to pre-operative low-impact recreational activity			

Please see Important Safety Information on page 21 and accompanying full Prescribing Information

PHASE

1

IMMEDIATE POST-OP

0-1 week following surgery

Immediately following surgery, it is important to maintain joint mobility and muscle tone without placing undue stress on the implant area. Prior to discharge, the patient also must be proficient in, and comfortable with, all aspects of home exercise and functional activities.

goal

- Maintain joint mobility and muscle tone while adhering to all post-operative precautions.

patient expectations

The week immediately following surgery will be spent managing pain and swelling with the careful introduction of movement.

- A comfortable setting is recommended and unnecessary movement should be restricted to protect the implant (rest, immobilization)
- RICE as directed (rest, ice, compression, elevation)
- Continuous passive motion (CPM) and basic exercises and activities as directed



PRIOR TO DISCHARGE

1. Ensure the patient has an initial appointment (or appropriate contacts) for outpatient physical therapy.
2. Ensure that the patient is aware that the next post-operative appointment with the orthopedic surgeon normally occurs within 4–6 weeks post-operative.
3. If required, ensure that patient has an appointment for the removal of sutures/staples, or is aware when they must be removed (generally within 8–10 days post-operative).
4. Instruct and educate the patient on the importance of following the RICE guidelines for edema control.
5. Reinforce WB and brace guidelines.
6. Review the home exercise regimen, ensuring the patient is proficient in safely performing these activities.
7. Review (and educate on) techniques for performing functional activities (i.e., stairs, bed transfers, showering, etc.), ensuring the patient is independent in safely performing these activities.
8. Ensure the patient is educated in wound healing, and how to assess changes in the wound and surrounding soft tissue that may indicate infection.

CONTRAINDICATIONS

1. Excessive load bearing (>20% of patient body weight) especially in combination with knee flexion
2. Ambulation without crutches and a protective knee brace
3. Generation of shear forces within the knee
4. Knee flexion beyond 30° for tibiofemoral grafts or 20° for patellofemoral
5. Active knee extension (especially against resistance)

REHABILITATION PLAN

Tibiofemoral joint	Patellofemoral joint
Weight bearing (WB) % of body weight	
<20%	<20%
Range of motion (ROM)	
Passive and active, progress from 0°–30°	Passive and active, progress from 0°–20°
Protective knee bracing	
Progress from 0°–30°	Locked at full knee extension
Ambulatory aids	
2 crutches	2 crutches

Initiate on post-operative Day 1 unless otherwise instructed by the operating surgeon.

1. Provide appropriate analgesics for pain control.
2. Commence CPM 12-24 hours post-operative, for a minimum of 1 hour daily to reduce the chance of intra-articular adhesions¹ and potentially speed up and improve the quality of tissue repair.^{1,2}
3. Fit a post-operative ROM control brace; this should be worn 24 hours per day for the first 3 weeks, unless PT is utilizing the CPM.
4. Apply cryotherapy as standard edema control (20 minutes with ice, at least 3 times per day).
5. Perform active dorsi-flexion and plantar-flexion exercises of the ankle to encourage lower extremity circulation.
6. Encourage isometric contraction of the quadriceps, hamstrings, and gluteal musculature to help maintain muscle tone and minimize muscle loss.^{3,4}
7. Oversee breathing exercises to ensure proper technique during therapeutic exercise.
8. Offer instruction and practice in proficient toe-touch ambulation (using 2 crutches, with 20% of body weight through the operated limb, unless otherwise indicated by the operating surgeon), and safety with bed transfers and stairs.
9. Provide detailed verbal and written instruction on how to perform activities of daily living and functional tasks, while adhering to post-operative precautions and appropriate WB status.

PHASE

2

RESTORE MOBILITY

2-3 weeks following surgery

As the immediate surgery phase is past, the patient should achieve pain-free and full passive knee extension, as well as limited WB. Additional focus is placed on maintaining muscle tone and ensuring proper wound healing and edema control.

goals

- ❑ Pain-free knee flexion of 90° for tibiofemoral grafts and 60° for patellofemoral grafts.
- ❑ Pain-free full passive knee extension.
- ❑ Independent in heel-toe gait using 2 crutches and a knee brace.
 - 30% of body weight for tibiofemoral grafts
 - 50% of body weight for patellofemoral grafts
- ❑ Adequate control of post-operative pain and swelling.
- ❑ Ability to generate an active, isometric quadriceps contraction.
- ❑ Independent with home-exercise program.

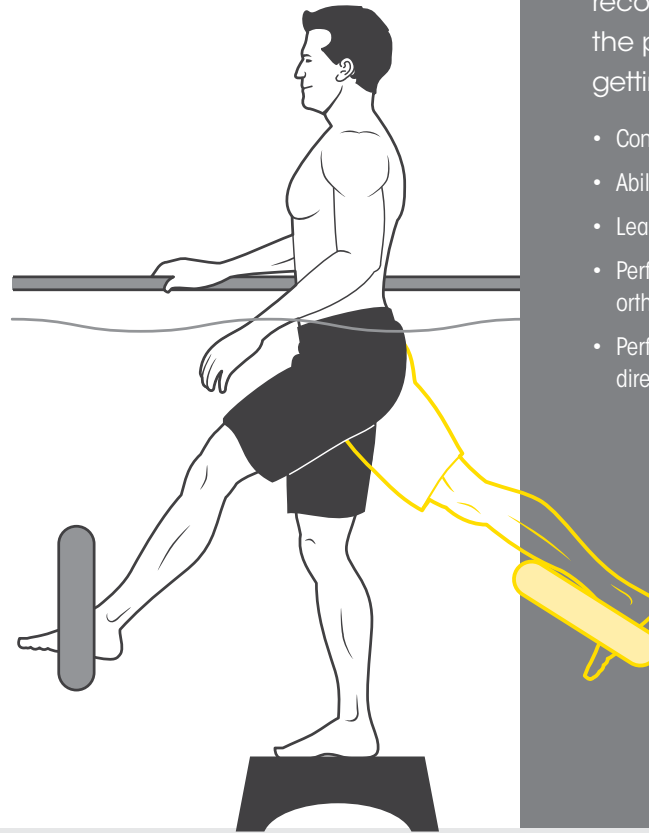

patient expectations

The stage following immediate recovery from surgery should provide the patient with the roadmap for getting back to a normal daily routine.

- Continue to manage pain, swelling, and wound care
- Ability to properly put on knee brace
- Learn to use crutches for daily activities
- Perform limited WB as directed by orthopedic surgeon
- Performance of home exercise program as directed by surgeon and physical therapist

INITIAL OUTPATIENT PT SESSION

1. Review the patient's level of pain and medication use.
2. Ensure the appropriate knee brace is obtained, correctly fitted, and adjusted appropriately (0°–30° of knee flexion, or as directed by the orthopedic surgeon).
3. Ensure proficiency with crutches, both during normal ambulation and while negotiating stairs.
4. Provide appropriate education, training, and proficiency with the desired level of partial WB ($\leq 20\%$, or as directed by the orthopedic surgeon).⁵
5. Review instructions and movement contraindications outlined by the orthopedic surgeon and hospital physical therapist as needed.
6. Review and progress the home exercise program based on the current post-operative timeline and patient status.

REHABILITATION PLAN

Tibiofemoral joint	Patellofemoral joint
Weight bearing (WB) % of body weight	
Progress from <20%–30%	Progress from <20%–50%
Range of motion (ROM)	
Active, progress from 30°–90°	Active, progress from 30°–60°
Protective knee bracing	
Progress from 30°–45°	Locked at full knee extension
Ambulatory aids	
2 crutches	2 crutches

ROM and flexibility exercises

- Use CPM at the end of each session for 20–30 minutes to reduce the chance of intra-articular adhesions⁶ and potentially speed up and improve the quality of tissue repair^{1,2}
- Passive and active heel slides
- Full knee extension
- Careful patellar mobilization in all directions

Strengthening exercises

- Isometric quadriceps contraction and co-contraction activities (aided with the use of neuromuscular electrical muscle stimulation to stimulate voluntary muscular contraction)
- Isometric gluteal, hamstrings, adductor, and calf contractions
- Straight-leg-raise activities (hip flexion, abduction, adduction, and extension)

Hydrotherapy exercises

- Deep-water walking (forwards, backwards, and sideways)
- Deep-water calf raises
- Straight-leg hip flexion, extension, abduction, and circumduction (with or without floatation devices for additional resistance)
- Passive knee flexion
- Stretching of hamstring and calf musculature

Symptom control

- Perform clearance and lymphatic remedial massage as needed to assist in the reduction of soft-tissue edema
- Perform cryotherapy, compression, and elevation regularly to assist in the reduction of soft tissue edema

PHASE

3

STRENGTHEN & STRAIGHTEN

4-6 weeks following surgery

Now that the patient is ambulating (with crutches), increasing WB and ROM, as appropriate, is called for. Strengthening exercises should also be augmented.

goals

- ❑ Pain-free active knee flexion to 125°.
- ❑ Independent in performing home exercises, including a straight-leg raise.
- ❑ Tibiofemoral graft patients should achieve a pain-free gait using 1-2 crutches. (dependent on WB status), a knee brace, and 60% WB pressure.
- ❑ Patellofemoral graft patients may be progressed to full WB as tolerated, following clearance from the orthopedic surgeon.

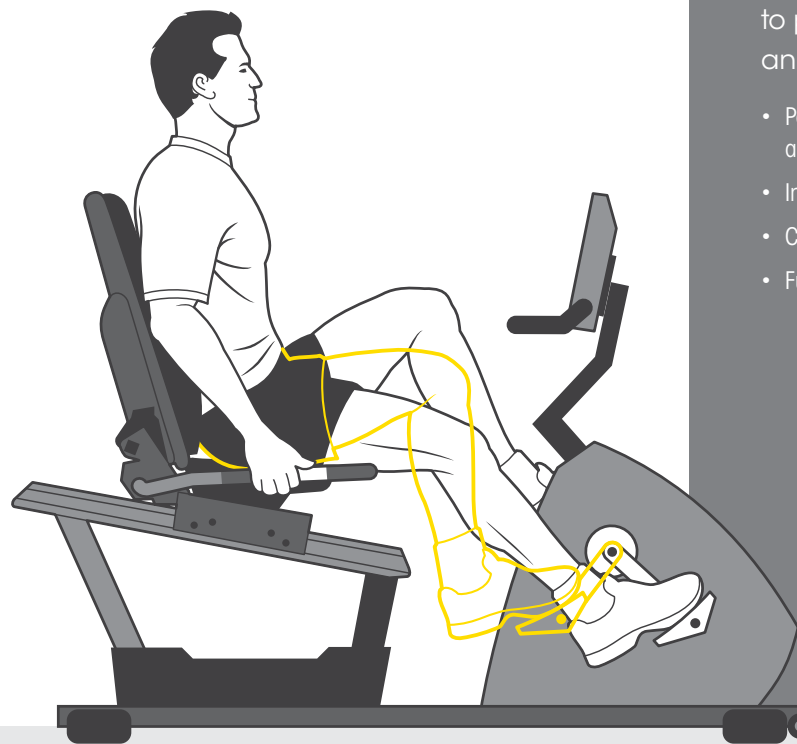

patient expectations

Independent with crutches for activities of daily living and established in a PT program, patients at this point should be able to progress with strengthening, WB, and ROM exercises.

- Performance of home exercise program as directed
- Independent use of crutches
- Continued increase in WB as directed
- Full extension ROM of the knee

REHABILITATION PLAN

Tibiofemoral joint	Patellofemoral joint
Weight bearing (WB) % of body weight	
Progress from <40%–60%	Progress from 75%–full
Range of motion (ROM)	
Active, progress from 110°–125°	Active, progress from 90°–125°
Protective knee bracing	
Progress from 45°–full extension	Use brace as required (beginning Week 6)
Ambulatory aids	
1-2 crutches	1-2 crutches (Weeks 4-5); 1 crutch as required (Week 6)

ROM and flexibility exercises

- Continue Phase 2 flexibility/stretching exercises
- Stretch hamstrings and calf musculature
- Carefully mobilize patella in all directions
- Use CPM to maximum comfortable range as required
- Focus WB on heel-to-toe pattern to encourage more natural gait

Strengthening exercises

- Continue Phase 2 strengthening exercises
- Progress straight-leg-raise activities (e.g., supine straightleg hip-flexion half-seated and/or with externally rotated foot)
- Introduce:
 - side-lying gluteal exercises with a flexed knee
 - standing-calf raises (dependent on WB status)
 - seated or standing weighted-hip adduction and abduction
 - trunk-strengthening exercises (e.g., supine sit-ups, weight-supported trunk flexion)
- Recumbent cycling (modified knee flexion; 90°) (Weeks 5–6)

Hydrotherapy exercises

- Continue Phase 2 hydrotherapy exercises
- Introduce:
 - active knee flexion (with floatation devices for additional resistance)
 - shallow-water walking (waist depth, dependent on WB status)
 - shallow-water calf raises
 - deep-water squatting activities
 - pool cycling (full knee ROM)

Symptom control

- Perform clearance and lymphatic remedial massage as required for edema
- Perform cryotherapy, compression, and elevation as required for edema



PHASE

4

INDEPENDENT MOVEMENT

7-12 weeks following surgery

Working toward movement free of ambulation devices and knee braces is a key aspect of this phase. Focus is placed on becoming thoroughly independent with the rehabilitation exercises, as clinic visits become less frequent.

goals

- ❑ Active knee ROM within anatomical limits.
- ❑ Pain-free six-minute walk test^{7,8} without the use of crutches or other assistive aids.
- ❑ Begin the use of an upright stationary bike without knee brace.
- ❑ Independent in performing home and gym-based exercises, for continuation of rehabilitation following clinic discharge, as instructed by surgeon and physical therapist.
- ❑ Begin proprioception exercises.
- ❑ Progression to full WB.

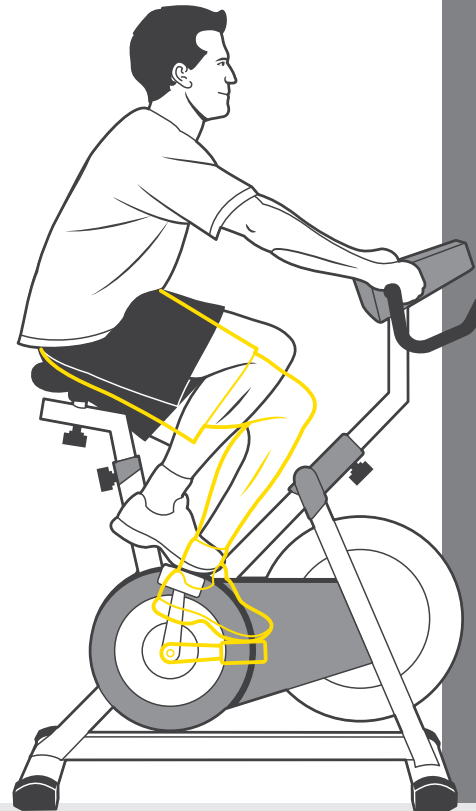

patient expectations

Phase 4 is a transitional stage of rehabilitation as the dependence on crutches and the knee brace are minimized and then discontinued.

- Independent with home exercise program and a clear understanding on how to safely progress as physical therapy visit frequency decreases
- Discontinue use of ambulatory devices, as directed by surgeon and physical therapist
- Progression to full WB

REHABILITATION PLAN

Tibiofemoral joint	Patellofemoral joint
Weight bearing (WB) % of body weight	
Progress from 80%–full (Weeks 8-10)	Full
Range of motion (ROM)	
Active, full (Weeks 7-8)	Active, full (Weeks 7-8)
Protective knee bracing	
Allow full knee flexion within brace	No brace
Ambulatory aids	
Full WB indoors, single crutch outdoors and in unfamiliar areas	No crutches

ROM and flexibility exercises

- Introduce passive knee ROM on rowing ergometer (Weeks 9–10)
- Carefully mobilize patella in all directions
- Conduct CPM to maximum comfortable range as required
- Continue Phase 2–3 strengthening exercises
- Continue standing weighted hip adduction and abduction
- Introduce weighted knee flexion (Week 8)
- Introduce upright (knee flexion: 105°–110°) cycling (Weeks 9–12)
- Continue Phase 2–3 flexibility/stretching exercises
- Stretch quadriceps musculature (Weeks 9–10)

Hydrotherapy exercises

- Continue Phase 2–3 hydrotherapy exercises
- Stretch quadriceps musculature
- Progress water squatting activities
- Introduce weight-supported lunge activities
- Introduce weight-supported “step up and down” activities

Symptom control

- Perform clearance and lymphatic remedial massage as required for edema
- Perform cryotherapy, compression and elevation as required for edema

Proprioception exercises

Introduced following the return to full WB, both within the hydrotherapy pool and the clinic setting. Slowly progress proprioceptive activities from partial to full WB positions by altering:

1. The patient’s postural position (i.e., seated to standing).
2. The environment in which the activity is to be undertaken (e.g., gym- or pool-based).
3. Proprioceptive input mechanisms (e.g., eyes open or closed).
4. The speed of movement.
5. The magnitude of the base of support (i.e., 2-legged to 1-legged).
6. The stability of the base of support (i.e., introduction of unstable surfaces including a soft mat or pillow, wobble board, dura disc, theraball or mini-trampoline).
7. Introducing “weight transfer” and/or “activity-specific drills” with other equipment.

Following the completion of Phase 4, patients generally undergo a 3-month post-operative assessment, and a written report is sent to the orthopedic surgeon to coincide with the patient’s review.



PHASE

5

RETURN TO DAILY ACTIVITY

3-6 months following surgery

The majority of patients can return to strenuous daily activities on a limited basis upon reaching this phase. Patients can either continue to attend the outpatient clinic once or twice per week independently (though group supervised), or should continue with their prescribed gym and home rehabilitation program independently.

goals

- ❑ Normal gait pattern without walking aids or a knee brace.
- ❑ Ability to negotiate stairs and mild gradients.
- ❑ A return to work, depending on the demands of the job.
- ❑ Proficiency in performing a weighted-leg press through 60°–90° of knee flexion, and with ≤50% of body weight pressure.
- ❑ Independent in performing full WB proprioception activities.

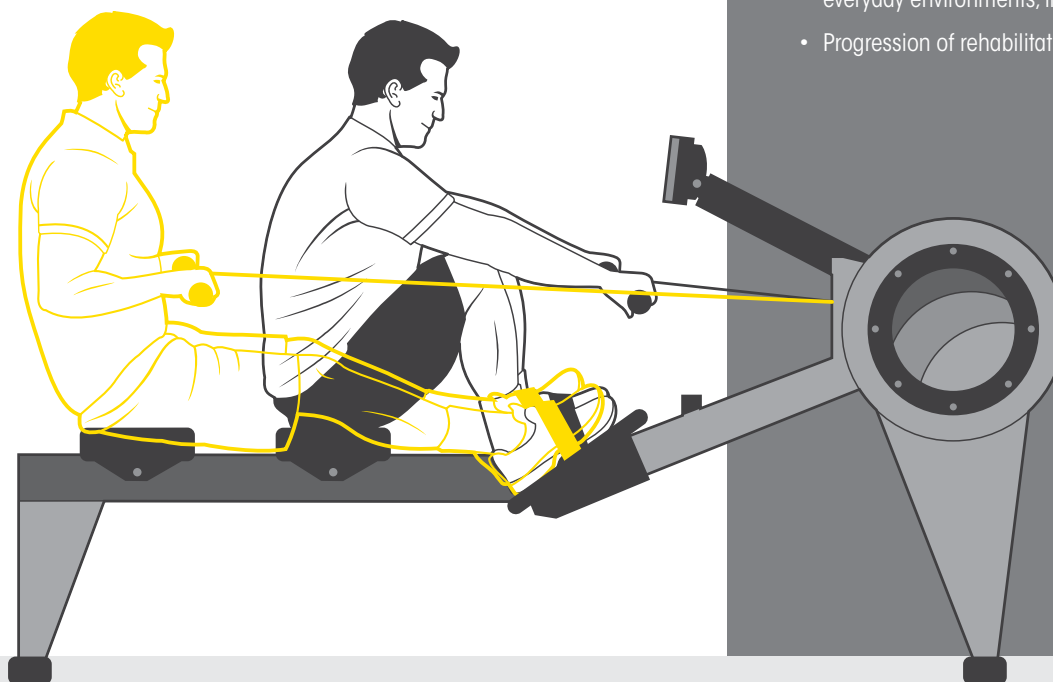

patient expectations

Patients will continue to progress with full WB rehabilitation activity. Patients should be able to return to everyday activity.

- Unimpeded, pain-free movement through everyday environments, including stairs
- Progression of rehabilitation activity

REHABILITATION PLAN

Tibiofemoral joint	Patellofemoral joint
Weight bearing (WB) % of body weight	
Full	Full
Range of motion (ROM)	
Full and pain-free active ROM	Full and pain-free active ROM
Protective knee bracing	
No brace	No brace
Ambulatory aids	
No crutches	No crutches

ROM and flexibility exercises

- Continue Phase 3–4 flexibility/stretching exercises and strengthening exercises
- Continue Phase 3–4 strengthening exercises
- Introduce bridging exercises
- Introduce standing single-leg calf raises
- Introduce modified open kinetic chain (OKC) exercises (i.e., terminal leg extension, with appropriate use based on lesion location and knee joint biomechanics)
- Introduce modified closed kinetic chain (CKC) exercises (e.g., inner range quadriceps and leg press activities)
- Progress upright stationary and outdoor road cycling
- Introduce rowing ergometry as tolerated



PHASE

6

RECREATIONAL ACTIVITIES

6-9 months following surgery

The patient returns to low-impact recreational activities

by gradually increasing the difficulty of their exercises.

goals

- ❑ Hamstring and calf strength within 80%–90% of the contralateral leg.
- ❑ Ability to tolerate walking distances of >3 miles (5 km).
- ❑ Ability to effectively negotiate uneven ground, including soft sand.
- ❑ Ability to return to low-impact recreational activities.

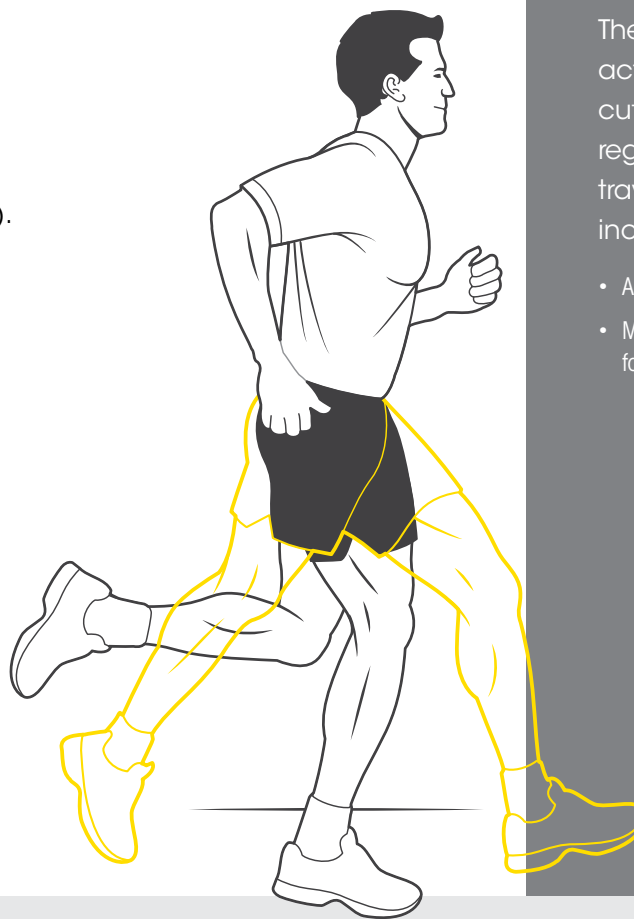

patient expectations

The patient can return to recreational activities, avoiding heavy impact, cutting, or pivoting. The patient has regained everyday function including traversing uneven or soft ground, inclines, and other obstacles.

- Ability to return to low-impact recreational activity
- Maintaining rehabilitation program is essential for continued progression

REHABILITATION PLAN

ROM and flexibility exercises

- Continuation of Phase 3–4 flexibility/stretching exercises

Strengthening exercises

- Continuation of Phase 3–4 strengthening exercises
- Progression and increased difficulty of OKC exercises
- Progression and increased difficulty of CKC exercises (e.g., step ups/downs, modified squat activities)
- Introduction of controlled running on a mini-trampoline



PHASE

7

RETURN TO FULL ACTIVITY

9–12 months following surgery

In this final phase patients should be able to resume normal functionality as well as low compression recreational activities. These activities are initially performed in isolation, and then with the appropriate equipment. (It is not the purpose of this document to outline a protocol of specific exercises and activities.)

goals

- ❑ Ability to perform all activities of daily living.
- ❑ Ability to commence running program.
- ❑ Resume dynamic recreational activities.

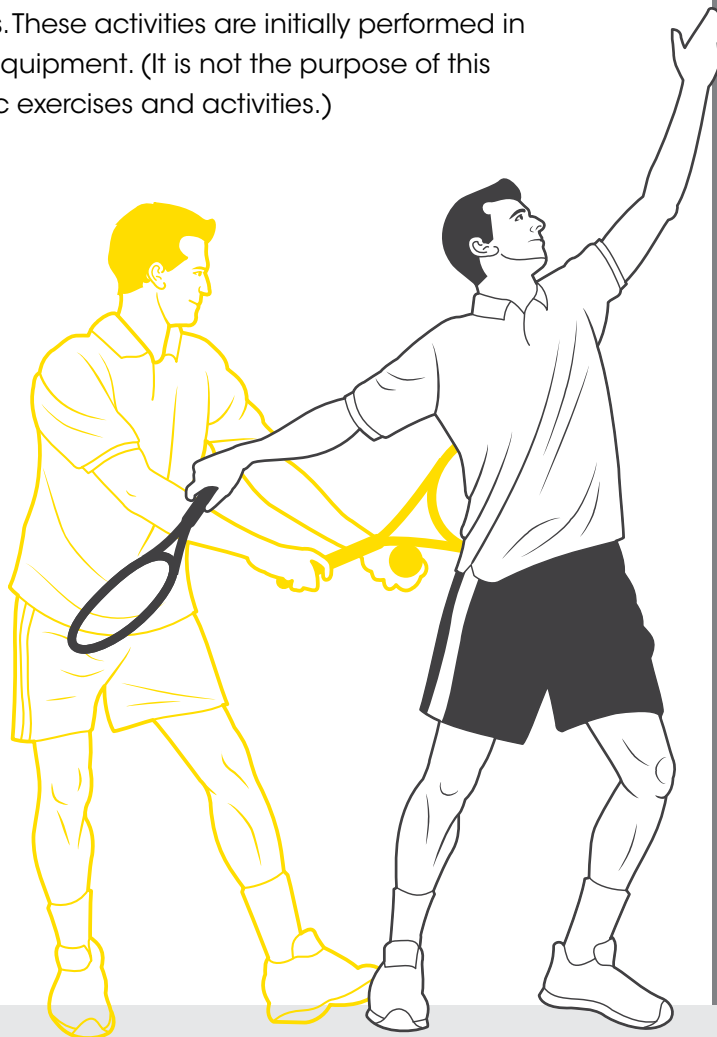

patient expectations

The patient is working toward the ability to make full demands on their knee as the repair tissue continues to mature.

- Commence a return to running program
- Expanded agility as these activities are added to their program
- A full return to recreational activities, working toward individual goals as the implant matures

RETURN TO ACTIVITIES*

It is not the purpose of this document to outline a protocol of specific exercises and activities. Both the patient and therapist must use their own discretion. Not only the graft maturation process should be considered but also the mental preparedness of the patient and the general physical function and level of specific knee strength, stability, and support. Individual patient variations must be evaluated when considering a patient's long-term outcome and ability to return to activities. In addition to the commitment and psychological profile of the patient, specific considerations include whether:

1. The patient's graft has matured to the point at which it is able to withstand the specific demands of the chosen activity.
2. The patient has been appropriately rehabilitated to the point at which he or she is able to physically and psychologically undertake the demands of the chosen activity.
3. The patient has undergone appropriate clinical assessment with an orthopedic surgeon experienced with the results of a MACI implant.

Cellular regeneration, matrix production, and adaptation of the regenerating tissue to natural function take time, and it is unrealistic and impractical to expect patients to return to their normal activities within the first post-operative year.

*Individual results may vary.

REHABILITATION PLAN

ROM and flexibility exercises

- Continuation of Phase 3–6 flexibility/stretching exercises and strengthening exercises
- Continuation of Phase 3–6 strengthening exercises
- Progression and increased difficulty of CKC exercises
- Introduction of agility exercises relevant to the patient's activities

Activities that generate high-compression, shear, and rotational loads are to be avoided until 12-18 months, or as directed by orthopedic surgeon.



RECOMMENDED READINGS

Ebert JR, Robertson WB, Lloyd DG, Zheng MH, Wood DJ, Ackland T. A prospective, randomized comparison of traditional and accelerated approaches of post-operative rehabilitation following autologous chondrocyte implantation: 2-year clinical outcomes. *Cartilage*. 2010;1:180-187.

Ebert JR, Fallon M, Robertson WB, Lloyd DG, Zheng MH, Wood DJ, Ackland T. Radiological assessment of accelerated versus traditional approaches to post-operative rehabilitation following matrix-induced autologous chondrocyte implantation. [published online ahead of print October 18, 2010]. *Cartilage*. doi:10.1177/1947603510380902.

Ebert JR, Robertson WB, Lloyd DG, Zheng MH, Wood DJ, Ackland T. Traditional vs accelerated approaches to post-operative rehabilitation following matrix-induced autologous chondrocyte implantation (MACI): comparison of clinical, biomechanical and radiographic outcomes. *Osteoarthritis Cartilage*. 2008;16:1131-40.

Ebert JR, Ackland TR, Lloyd DG, Wood DJ. Accuracy of partial weight bearing after autologous chondrocyte implantation. *Arch Phys Med Rehabil*. 2008;89(8):1528-34.

Hambly K, Bobic V, Wondrasch B, Van Assche D, Marlovits S. Autologous Chondrocyte Implantation Post-operative Care and Rehabilitation: Science and Practice. *Am J Sports Med*. 2006;34:1-19.

Reinold MM, Wilk KE, Macrina LC, Dugas JR, Cain EL. Current concepts in the rehabilitation following articular cartilage repair procedures in the knee. *J Orthop Sports Phys Ther*. 2006;36(10):774-94.

Riegger-Krugh CL, McCarty EC, Robinson MS, Wegzyn DA. Autologous chondrocyte implantation: current surgery and rehabilitation. *Med Sci Sports Exerc*. 2008;40(2):206-14.

Wondrasch B, Zak L, Welsch G, Marlovits S. Effect of Accelerated Weightbearing After Matrix-Associated Autologous Chondrocyte Implantation on the Femoral Condyle on Radiographic and Clinical Outcome After 2 Years. A Prospective, Randomized Controlled Pilot Study. *Am J Sports Med*. 2009.

REFERENCES

1. O'Driscoll S, Keeley F, Salter R. Durability of regenerated articular cartilage produced by free autogeneous periosteal grafts in major full-thickness defects in joint surfaces under the influence of continuous passive motion. *J Bone Joint Surg Am*. 1988;70:595-606.
2. Salter RB. The physiologic basis of continuous passive motion for articular cartilage healing and regeneration. *Hand Clin*. 1994;10(2):211-9.
3. McAllister DR, Joyce MJ, Mann BJ, Vangsnest CT Jr. Allograft update: the current status of tissue regulation, procurement, processing, and sterilization. *Am J Sports Med*. 2007;35:2148-2158.
4. Minas T. The role of cartilage repair techniques, including chondrocyte transplantation, in focal chondral knee damage. *Instructional Course Lectures*. 1999;48:629-43.
5. Ebert JR, Ackland T, Lloyd DG, Wood DJ. Accuracy of partial weight bearing after autologous chondrocyte implantation. *Arch Phys Med Rehabil*. 2008;89(8):1528-34.
6. Minas T, Peterson L. Autologous chondrocyte implantation. *Op Tech in Orth*. 1997;7(4):323-333.
7. Ebert JR, Robertson WB, Lloyd DG, Zheng MH, Wood DJ, Ackland T. Traditional vs accelerated approaches to post-operative rehabilitation following matrix-induced autologous chondrocyte implantation (MACI): comparison of clinical, biomechanical and radiographic outcomes. *Osteoarthritis Cartilage*. 2008;16:1131-40.
8. Enright PL. The six-minute walk test. *Respir Care*. 2003;48(8):783-5.
9. Gillogly SD, Myers TH, Reinold MM. Treatment of Full-Thickness Chondral Defects in the Knee With Autologous Chondrocyte Implantation. *J Orthop Sport Phys Ther*. 2006;36(10):751-764.

IMPORTANT SAFETY INFORMATION

INDICATION

MACI® (autologous cultured chondrocytes on porcine collagen membrane) is an autologous cellularized scaffold product that is indicated for the repair of single or multiple symptomatic, full-thickness cartilage defects of the adult knee, with or without bone involvement.

MACI is intended for autologous use and must only be administered to the patient for whom it was manufactured. The implantation of MACI is to be performed via an arthrotomy to the knee joint under sterile conditions.

The amount of MACI administered is dependent upon the size (surface in cm²) of the cartilage defect. The implantation membrane is trimmed by the treating surgeon to the size and shape of the defect, to ensure the damaged area is completely covered, and implanted cell-side down.

Limitations of Use

Effectiveness of MACI in joints other than the knee has not been established.

Safety and effectiveness of MACI in patients over the age of 55 years have not been established.

IMPORTANT SAFETY INFORMATION

MACI is contraindicated in patients with a known history of hypersensitivity to gentamicin, other aminoglycosides, or products of porcine or bovine origin. MACI is also contraindicated for patients with severe osteoarthritis of the knee, inflammatory arthritis, inflammatory joint disease, or uncorrected congenital blood coagulation disorders. MACI is also not indicated for use in patients who have undergone prior knee surgery in the past 6 months, excluding surgery to procure a biopsy or a concomitant procedure to prepare the knee for a MACI implant.

MACI is contraindicated in patients who are unable to follow a physician-prescribed post-surgical rehabilitation program.

The safety of MACI in patients with malignancy in the area of cartilage biopsy or implant is unknown. Expansion of present malignant or dysplastic cells during the culturing process or implantation is possible.

Patients undergoing procedures associated with MACI are not routinely tested for transmissible infectious diseases. A cartilage biopsy and MACI implant may carry the risk of transmitting infectious diseases to healthcare providers handling the tissue. Universal precautions should be employed when handling the biopsy samples and the MACI product.

Final sterility test results are not available at the time of shipping. In the case of positive sterility results, health care provider(s) will be contacted.

To create a favorable environment for healing, concomitant pathologies that include meniscal pathology, cruciate ligament instability and joint misalignment, must be addressed prior to or concurrent with the implantation of MACI.

Local treatment guidelines regarding the use of thromboprophylaxis and antibiotic prophylaxis around orthopaedic surgery should be followed. Use in patients with local inflammations or active infections in the bone, joint, and surrounding soft tissue should be temporarily deferred until documented recovery.

The MACI implant is not recommended during pregnancy. For implantations post-pregnancy, the safety of breast feeding to infant has not been determined.

Use of MACI in pediatric patients (younger than 18 years of age) or patients over 65 years of age has not been established.

The most frequently occurring adverse reactions reported for MACI (≥5%) were arthralgia, tendonitis, back pain, joint swelling, and joint effusion.

Serious adverse reactions reported for MACI were arthralgia, cartilage injury, meniscus injury, treatment failure, and osteoarthritis.

Please see accompanying [full Prescribing Information](#)



autologous cultured
chondrocytes
on porcine
collagen membrane



64 Sidney Street
Cambridge, MA 02139
800-453-6948
www.maci.com

MACI® and MyCartilage Care® are registered trademarks of Vericel Corporation.
©2018 Vericel Corporation. All rights reserved. PPUS.MAC.0454



www.MyCartilageCare.com

1-877-872-4643

MyCartilage Care is a support program created specifically for patients undergoing MACI treatment for cartilage defects of the knee.

For more information, please see accompanying [full Prescribing Information](#), or visit MACI.com

HIGHLIGHTS OF PRESCRIBING INFORMATION

These highlights do not include all the information needed to use MACI safely and effectively. See full prescribing information for MACI.

MACI® (autologous cultured chondrocytes on porcine collagen membrane)

Cellular sheet for autologous implantation

Initial U.S. Approval: 2016

RECENT MAJOR CHANGES

Dosage and Administration, shaping the MACI implant (2.2) 06/2017

INDICATIONS AND USAGE

MACI® is an autologous cellularized scaffold product indicated for the repair of symptomatic, single or multiple full-thickness cartilage defects of the knee with or without bone involvement in adults. (1)

Limitations of Use

- Effectiveness of MACI in joints other than the knee has not been established.
- Safety and effectiveness of MACI in patients over the age of 55 years have not been established.

DOSAGE AND ADMINISTRATION

For autologous implantation only.

- Contact Vericel at 1-800-453-6948 or www.MACI.com regarding training materials for surgical implantation of MACI. (2)
- The amount of MACI implanted depends on the size (surface area in cm²) of the cartilage defect. (2.1)
- MACI should be trimmed to the size and shape of the defect and implanted with the cell-side down. (2.2)

DOSAGE FORMS AND STRENGTHS

Each 3 x 5 cm cellular sheet (MACI implant) consists of autologous cultured chondrocytes on a resorbable porcine Type I/III collagen membrane, at a density of at least 500,000 cells per cm². (3)

CONTRAINDICATIONS

- Known history of hypersensitivity to gentamicin, other aminoglycosides, or products of porcine or bovine origin. (4)
- Severe osteoarthritis of the knee. (4)

- Inflammatory arthritis, inflammatory joint disease, or uncorrected congenital blood coagulation disorders. (4)
- Prior knee surgery (within 6 months), excluding surgery to procure a biopsy or a concomitant procedure to prepare the knee for a MACI implant. (4)
- Inability to cooperate with a physician-prescribed post-surgical rehabilitation program. (4)

WARNINGS AND PRECAUTIONS

- Safety of MACI in patients with malignancy in the area of cartilage biopsy or implant is unknown. Expansion of malignant or dysplastic cells present in biopsy tissue during manufacture and subsequent implantation may be possible. (5.1)
- Because patients undergoing procedures associated with MACI are not routinely tested for transmissible infectious diseases, cartilage biopsy and MACI implant may carry risk of transmitting infectious diseases. (5.2)
- Local inflammation or active infection in the bone, joint, and surrounding soft tissue, meniscal pathology, cruciate ligament instability, and misalignment should be assessed and treated prior to or concurrent with MACI implantation. (5.3)
- Final sterility test results are not available at the time of shipping. (5.4)

ADVERSE REACTIONS

The most frequently occurring adverse reactions (≥5%) reported for MACI were arthralgia, tendonitis, back pain, joint swelling, and joint effusion. (6)

Serious adverse reactions reported for MACI were arthralgia, cartilage injury, meniscus injury, treatment failure, and osteoarthritis. (6)

To report SUSPECTED ADVERSE REACTIONS, contact Vericel at 1-800-453-6948 or FDA at 1-800-FDA-1088 or www.fda.gov/medwatch for voluntary reporting of adverse reactions.

USE IN SPECIFIC POPULATIONS

Pregnancy: Because MACI implantation requires invasive surgical procedures, use in pregnancy is not recommended. (8.1)

See 17 for PATIENT COUNSELING INFORMATION

Revised: 06/2017

FULL PRESCRIBING INFORMATION: CONTENTS*

1 INDICATIONS AND USAGE

2 DOSAGE AND ADMINISTRATION

- 2.1 Dosage
- 2.2 Preparation and Implantation Procedure
- 2.3 Postsurgical Rehabilitation

3 DOSAGE FORMS AND STRENGTHS

4 CONTRAINDICATIONS

5 WARNINGS AND PRECAUTIONS

- 5.1 Malignancy
- 5.2 Transmissible Infectious Diseases
- 5.3 Presurgical Assessment of Comorbidities
- 5.4 Product Sterility

6 ADVERSE REACTIONS

- 6.1 Clinical Trials Experience
- 6.2 Postmarketing Experience

8 USE IN SPECIFIC POPULATIONS

- 8.1 Pregnancy

8.2 Lactation

8.4 Pediatric Use

8.5 Geriatric Use

11 DESCRIPTION

12 CLINICAL PHARMACOLOGY

12.1 Mechanism of Action

12.3 Pharmacokinetics

13 NONCLINICAL TOXICOLOGY

13.1 Carcinogenesis, Mutagenesis, Impairment of Fertility

13.2 Animal Toxicology and/or Pharmacology

14 CLINICAL STUDIES

15 REFERENCES

16 HOW SUPPLIED/STORAGE AND HANDLING

17 PATIENT COUNSELING INFORMATION

*Sections or subsections omitted from the full prescribing information are not listed.

FULL PRESCRIBING INFORMATION

1 INDICATIONS AND USAGE

MACI[®] (autologous cultured chondrocytes on porcine collagen membrane) is an autologous cellularized scaffold product indicated for the repair of single or multiple symptomatic, full-thickness cartilage defects of the knee with or without bone involvement in adults.

Limitations of Use

- Effectiveness of MACI in joints other than the knee has not been established.
- Safety and effectiveness of MACI in patients over the age of 55 years have not been established.

2 DOSAGE AND ADMINISTRATION

For Autologous Implantation Only.

Contact Vericel at 1-800-453-6948 or www.MACI.com regarding training materials for surgical implantation of MACI.

2.1 Dosage

- The amount of MACI implanted depends on the size (surface area in cm²) of the cartilage defect. The surgeon should trim the MACI implant to the size and shape of the defect, to ensure the damaged area is completely covered.
- MACI implant is for single-use. Multiple implants may be used if there is more than one defect. The size of MACI is adjusted for the size of each cartilage defect.

2.2 Preparation and Implantation Procedure

Preparation

- Confirm that the patient's identity matches the patient's identifiers on the MACI labels.
- Inspect the sealed MACI packaging for leaks and for any evidence of damage or contamination.
- DO NOT USE if the patient identifiers do not match, or there are signs of damage to the packaging. Contact MACI representative immediately or call Vericel Customer Care at 1-800-453-6948.
- Keep MACI at room temperature in its original packaging (outer shipping box). Do not unpack the MACI shipping box until the surgical site has been prepared.

Implantation Procedure

- Perform implantation procedure during arthrotomy using sterile surgical techniques.

- Follow the implantation with an appropriate, physician-prescribed rehabilitation program [see *Dosage and Administration (2.3)*].

Preparing Defect

- For chondral defects, remove all damaged and fibrous tissue on the defect bed. Debride the defect bed back to stable cartilage with vertical walls down to the subchondral bone by removing as little healthy cartilage as possible (Figure 1). Do not penetrate the subchondral bone.

Figure 1: Preparing Defect Bed

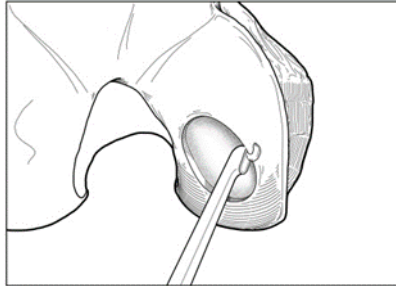

- For osteochondral defects, debride the defect bed back to stable cartilage with vertical walls down to healthy stable bone.
- Avoid bleeding through the subchondral plate. If bleeding occurs, use a suitable hemostatic agent to control the bleeding.

Creating Defect Template

- Create an exact template of the defect (Figure 2).

Figure 2: Creating Defect Template

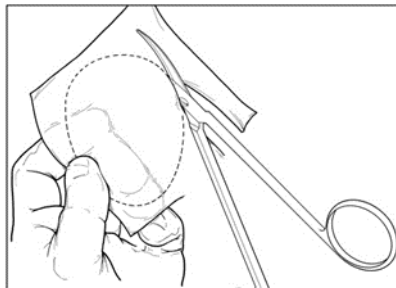

- Create orientation markers on the template to assist with proper orientation of the MACI implant. Turn the marked template over to ensure that the cells will be properly placed into the defect.

Preparing MACI Implant

- Unpacking MACI implant box (outside sterile field).
 - Unpack MACI implant shipping box.
 - Remove the outer bag containing a covered dish holding the MACI implant.

Note: Keep the dish upright at all times.

- Remove the self-seal pouch containing the dish from the outer bag (Figure 3).

Figure 3: Covered Dish in Self-Sealed Pouch

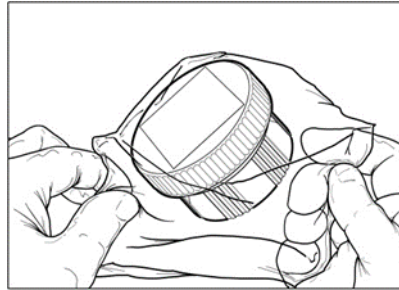

- Tear notches on the self-seal pouch to open the pouch and remove the covered dish.

Note: Do not remove the MACI implant from the dish until ready to be used.

- Unpacking the MACI implant dish (Figure 4)
 - When ready, a team member outside the sterile field but adjacent to the sterile prep table, will twist open and remove the lid from the dish.
 - Sterile field team member using sterile forceps will remove and discard the inner 5-pronged ring.
 - Sterile field team member will use 2 sterile non-tooth forceps to grasp the MACI implant corners and place the MACI implant onto the sterile work surface.

Figure 4: Unpacking MACI Implant

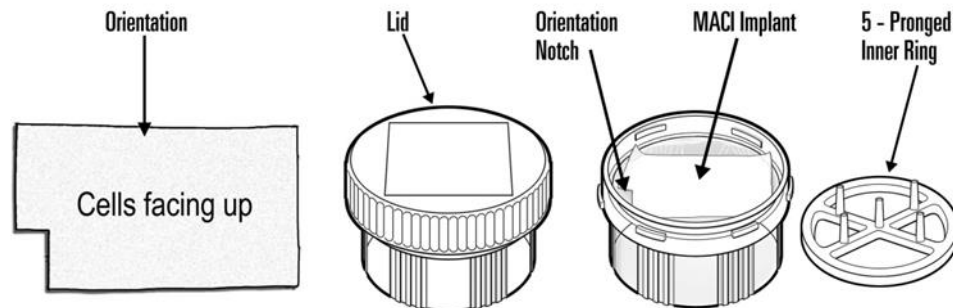

- The MACI implant has a rough side and a smooth side. The cells are seeded on the rough side and are facing up in the MACI dish. A notch in the lower left corner of the implant indicates that the cell-side is facing up. The cell-side of the MACI implant should remain facing up at all times until placement into the defect.

Note: The MACI implant must remain hydrated with the shipping media. Use the media from the dish to hydrate the implant if it ever starts to become dry after removal from the dish.

- Shaping the MACI implant
 - To maintain proper orientation, turn the template over and place it underneath the MACI implant, against the smooth, non-seeded side. The template should be visible through the translucent implant.

Note: Ensure minimal contact with the cell-seeded surface of the MACI implant.

- Using the template as a guide, cut the MACI implant to the correct size and shape.
- Place the custom-cut implant into a sterile intermediary dish, ensuring the cell-side up orientation and with adequate media from shipping dish to keep the implant hydrated.
- Place any remaining MACI implant into a separate intermediary dish with adequate media from the shipping dish to keep the implant hydrated. Discard if unused by the end of the implantation.

Placing MACI Implant

- Ensure defect area is dry and free of bleeding.
- Apply a thin layer of fibrin sealant to the entire base of the defect (bone) bed.
- Maintaining appropriate rotational orientation, place the custom-cut implant onto the defect bed cell-side down.
- Apply light digital pressure to the implant for approximately 3 minutes.
- Fibrin sealant may also be applied to the rim (periphery) of the implant. MACI implant fixation may also be supplemented with interrupted resorbable sutures if desired or if conditions warrant, particularly if the defect is uncontained (i.e, the cartilage defect is not 100% surrounded by a stable cartilage rim) or the lesion is larger than 10 cm².

2.3 Postsurgical Rehabilitation

A physician-prescribed rehabilitation program that includes early mobilization, joint range of motion, and weight bearing is recommended to promote graft maturation and reduce the risk of graft delamination, postoperative thromboembolic events, and joint stiffness. Stage this program to promote a progressive return to full joint range of motion and weight-bearing as well as muscle strengthening and conditioning. Return to recreational and sporting activity should be in consultation with healthcare professionals.

3 DOSAGE FORMS AND STRENGTHS

MACI implant is available as a cellular sheet, 3 x 5 cm, with a 0.5-cm² section removed from the lower left-hand corner, consisting of autologous cultured chondrocytes on a resorbable Type I/III collagen membrane at a density of at least 500,000 cells per cm².

4 CONTRAINDICATIONS

MACI is contraindicated in patients with the following conditions:

- Known history of hypersensitivity to gentamicin, other aminoglycosides, or products of porcine or bovine origin. [*see Description (11)*]
- Severe osteoarthritis of the knee (Kellgren-Lawrence grade 3 or 4).
- Inflammatory arthritis, inflammatory joint disease, or uncorrected congenital blood coagulation disorders.
- Prior knee surgery (6 months), excluding surgery to procure a biopsy or a concomitant procedure to prepare the knee for a MACI implant.
- Inability to cooperate with a physician-prescribed post-surgical rehabilitation program [*See Dosage and Administration (2.3)*].

5 WARNINGS AND PRECAUTIONS

5.1 Malignancy

The safety of MACI used in patients with malignancy in the area of cartilage biopsy or implant is unknown. The potential exists for expansion of malignant or dysplastic cells present in biopsy tissue during manufacture and subsequent implantation. In addition, implantation of normal autologous chondrocytes could theoretically stimulate growth of malignant cells in the area of the implant, although there have been no such incidents reported in humans or animals.

5.2 Transmissible Infectious Diseases

MACI is intended solely for autologous use. Patients undergoing the surgical procedures associated with MACI are not routinely tested for transmissible infectious diseases. Therefore, the cartilage biopsy and the MACI implant may carry the risk of transmitting infectious diseases to personnel handling these tissues. Accordingly, healthcare providers should employ universal precautions in handling the biopsy samples and the MACI product.

Product manufacture includes reagents derived from animal materials. All animal-derived reagents are tested for viruses, retroviruses, bacteria, fungi, yeast, and mycoplasma before use. Bovine materials are sourced to minimize the risk of transmitting a prion protein that causes bovine spongiform encephalopathy and may cause a rare fatal condition in humans called variant Creutzfeldt-Jakob disease.

These measures do not totally eliminate the risk of transmitting these or other transmissible infectious diseases and disease agents. Report the occurrence of a transmitted infection to Vericel Corporation at 1-888-453-6948.

5.3 Presurgical Assessment of Comorbidities

To create a favorable environment for healing, assess and treat the following conditions prior to or concurrent with implantation with MACI:

- Local inflammation or active infection in the bone, joint, and surrounding soft tissue: patients should be deferred until complete recovery.
- Meniscal pathology: presence of an unstable or torn meniscus requires partial resection, repair, or replacement prior to or concurrent with MACI implantation. MACI is not recommended in patients with a total meniscectomy.
- Cruciate ligament instability: the joint should not possess excessive laxity, which may create excessive shear and rotational forces across the joint. Both anterior and posterior cruciate ligaments should be stable or undergo reconstruction prior to or concurrent with MACI implantation.
- Misalignment: the tibio-femoral joint should be properly aligned, and patella tracking should be normalized. Varus or valgus misalignment of the tibio-femoral joint and abnormal patella tracking may abnormally load joint surfaces and jeopardize the implant. Misalignment and patella tracking should be addressed with a corrective osteotomy or similar corrective procedure prior to or concurrent with MACI implantation.

5.4 Product Sterility

MACI is shipped after passing preliminary test results from in-process microbial tests. A final sterility test is initiated prior to shipping, but the result will not be available prior to implantation. If microbial contamination is detected after the product has been shipped, Vericel will notify the healthcare provider(s) and recommend appropriate actions.

6 ADVERSE REACTIONS

The most frequently occurring adverse reactions ($\geq 5\%$) reported for MACI were arthralgia, tendonitis, back pain, joint swelling, and joint effusion.

Serious adverse reactions reported for MACI were arthralgia, cartilage injury, meniscus injury, treatment failure, and osteoarthritis.

6.1 Clinical Trials Experience

Because clinical trials are conducted under widely varying conditions, adverse reaction rates observed in the clinical trials of a product cannot be directly compared to rates in the clinical trials of another product and may not reflect the rates observed in practice.

In a 2-year prospective, multicenter, randomized, open-label, parallel-group clinical trial¹, 144 patients, ages 18 to 54 years, were randomized to receive a 1-time treatment with MACI or microfracture (1:1, 72 patients in each treatment group). Demographic characteristics of patients in the trial were similar in both treatment groups. The majority of patients were male (62.5% MACI, 66.7% microfracture), and the mean ages were 34.8 (MACI) and 32.9 (microfracture)

years. Overall, 70 patients in the MACI group and 67 patients in the microfracture group completed 2 years of follow-up.

In addition, all 144 subjects from the 2-year clinical trial had the option to enroll in a 3-year follow-up study (extension study). Safety and efficacy assessments were performed at yearly scheduled visits. The demographic characteristics of patients (N = 128) enrolled in the extension study were similar in both treatment groups and consistent with the overall population of the 2-year clinical trial.

The proportion of patients with at least 1 subsequent surgical procedure (any surgical procedure performed on the treated knee joint, including arthroscopy, arthrotomy, or manipulation under anesthesia) in the 2 years following study treatment was comparable between treatment groups (8.3% in the MACI group and 9.7% in the microfracture group).

Adverse reactions reported in $\geq 5\%$ of patients in either treatment group in the 2-year clinical trial are provided in Table 1.

Table 1. Adverse Reactions in $\geq 5\%$ of Patients in Any Treatment Group in the 2-Year Clinical Trial

System Organ Class	MACI n = 72 n (%)	Microfracture n = 72 n (%)
Musculoskeletal and Connective Tissue Disorders		
Arthralgia	37 (51.4)	46 (63.9)
Back pain	8 (11.1)	7 (9.7)
Joint swelling	7 (9.7)	4 (5.6)
Joint effusion	5 (6.9)	4 (5.6)
Injury, Poisoning and Procedural Complications		
Cartilage injury	3 (4.2)	9 (12.5)
Ligament sprain	3 (4.2)	5 (6.9)
Procedural pain	3 (4.2)	4 (5.6)
General Disorders and Administration Site Conditions		
Treatment failure	1 (1.4)	4 (5.6)

In the 3-year extension study, adverse reactions reported in $\geq 5\%$ of patients were (MACI vs microfracture): arthralgia (46.2% vs 50.8%), tendonitis (6.2% vs 1.6%), back pain (4.6% vs 6.3%), osteoarthritis (4.6% vs 7.9%), joint effusion (3.1% vs 7.9%), cartilage injury (6.2% vs 15.9%), procedural pain (3.1% vs 7.9%), ligament sprain (1.5% vs 7.9%), and treatment failure (4.6% vs 7.9%).

Serious adverse reactions reported in patients in either treatment group for integrated data across the 2-year clinical trial and the 3-year extension study are provided in Table 2.

Table 2. Serious Adverse Reactions in Patients in Any Treatment Group Across the 2-Year Clinical Trial and the 3-Year Extension Study

System Organ Class	MACI n = 72 n (%)	Microfracture n = 72 n (%)
Musculoskeletal and Connective Tissue Disorders		
Arthralgia	1 (1.4)	7 (9.7)
Joint Lock	0	3 (4.2)
Meniscus Injury	3 (4.2)	0
Osteoarthritis	3 (4.2)	0
Injury, Poisoning and Procedural Complications		
Cartilage injury	3 (4.2)	8 (11.1)
General Disorders and Administration Site Conditions		
Treatment failure	3 (4.2)	7 (9.7)

6.2 Postmarketing Experience

Graft complication (e.g., abnormalities to the repair graft that become symptomatic; this could include graft overgrowth [tissue hypertrophy], under-fill or damage to the repair tissue that has elicited a painful response, or mechanical symptoms), graft delamination (i.e., a dislodging of the repair graft from the underlying subchondral bone that has become symptomatic; this can be measured as marginal, partial, or a complete delaminated graft), and tendonitis have been reported during use of MACI outside the United States. Because these reactions are reported voluntarily from a population of uncertain size, it is not always possible to reliably estimate their frequency or establish a causal relationship to MACI exposure.

8 USE IN SPECIFIC POPULATIONS

8.1 Pregnancy

Risk Summary

MACI implantation requires invasive surgical procedures; therefore use during pregnancy is not recommended. Limited clinical data on patients exposed to MACI during pregnancy are available. There are insufficient data with MACI use in pregnant women to inform a product-associated risk. Animal reproduction studies have not been conducted with MACI. In the U.S. general population, the estimated background risk of major birth defects and miscarriage in clinically recognized pregnancies is 2-4% and 15-20%, respectively.

8.2 Lactation

Risk Summary

There is no information regarding the presence of MACI in human milk, the effects on the breastfed infant, or the effects on milk production. The developmental and health benefits of breastfeeding should be considered along with the mother's clinical need for MACI and any potential adverse effects on the breastfed infant from MACI or from the underlying maternal condition.

8.4 Pediatric Use

The safety and effectiveness of MACI in pediatric patients have not been established.

8.5 Geriatric Use

The safety and effectiveness of MACI in patients over 65 years of age have not been established. Clinical trials of MACI did not include subjects over the age of 55.

11 DESCRIPTION

MACI, autologous cultured chondrocytes on porcine collagen membrane, is a cellular sheet that consists of autologous chondrocytes seeded on a 3 x 5 cm, resorbable porcine Type I/III collagen membrane, for implantation into cartilage defects of the knee. The active ingredients of MACI are the autologous cultured chondrocytes and porcine Type I/III collagen. The autologous chondrocytes are propagated in cell culture and are seeded on the collagen at a density of 500,000 to 1,000,000 cells per cm². The final MACI implant contains at least 500,000 cells per cm² and does not contain any preservative.

The product manufacture also uses reagents derived from animal materials. The resorbable, Type I/III, collagen membrane, which is a component of MACI, is porcine-derived. Fetal bovine serum is a component in the culture medium used to propagate the autologous chondrocytes; therefore, trace quantities of bovine-derived proteins may be present in MACI. These animal-derived reagents are tested for viruses, retroviruses, bacteria, fungi, yeast, and mycoplasma before use.

MACI may contain residual gentamicin because it is included during manufacture. Gentamicin is not included in the transport medium used to maintain product stability. Studies determined an average of 9.2 µg residual gentamicin per MACI implant.

A final sterility test is initiated prior to shipping, but the result will not be available prior to implantation. Passing results from preliminary in-process microbial tests are required for release of MACI for shipping.

12 CLINICAL PHARMACOLOGY

12.1 Mechanism of Action

No clinical pharmacology studies have been conducted with MACI and a mechanism of action has not been established.

12.3 Pharmacokinetics

Clinical pharmacokinetic studies have not been performed with MACI. Studies in rabbits and horses indicated that the membrane is resorbed over a period of at least 6 months following implantation.

13 NONCLINICAL TOXICOLOGY

13.1 Carcinogenesis, Mutagenesis, Impairment of Fertility

Studies to evaluate the carcinogenicity or impairment of fertility potential of MACI have not been performed. In vitro studies have shown that the expansion process for chondrocytes does not induce changes to the cellular karyotype.

Four studies (*in vitro* and *in vivo*) were conducted to assess the genotoxic potential of the collagen membrane. The results from these studies demonstrated that the collagen membrane was non-mutagenic.

13.2 Animal Toxicology and/or Pharmacology

Implantation of analogous products in critical-size defects in the hind limbs of rabbits and horses did not reveal any serious safety concerns. The products consisted of the same membrane as MACI with rabbit or horse cells, respectively. Non-clinical testing has shown that the collagen membrane is not toxic and is compatible with biological tissue.

14 CLINICAL STUDIES

The effectiveness of MACI implant was evaluated in a 2-year prospective, multicenter, randomized, open-label, parallel-group study, SUMMIT (Superiority of MACI implant versus Microfracture Treatment in patients with symptomatic articular cartilage defects in the knee),¹ which enrolled a total of 144 subjects, ages 18 to 54 years, with at least one symptomatic Outerbridge Grade III or IV focal cartilage defect on the medial femoral condyle, lateral femoral condyle, and/or the trochlea. Failure of a prior cartilage surgery was not required for study entry. The subjects were randomized to receive either a 1-time treatment with MACI or microfracture. The co-primary efficacy endpoint was change from baseline to Week 104 for the subject's Knee injury and Osteoarthritis Outcome Score (KOOS) in two subscales: Pain and Function (Sports and Recreational Activities [SRA])². Safety also was evaluated through Week 104 [*see Adverse Reactions (6.1)*].

Of the 72 subjects randomized to MACI, 70 completed the study and 2 discontinued prematurely (1 due to an adverse event [AE] and 1 wished to withdraw). Of the 72 subjects randomized to microfracture, 67 completed the study and 5 discontinued prematurely (1 due to an AE, 1 wished to withdraw, and 3 due to lack of clinical benefit).

At Week 104, KOOS pain and function (SRA) had improved from baseline in both treatment groups, but the improvement was statistically significantly ($p = 0.001$) greater in the MACI group compared with the microfracture group (Table 3).

Table 3. Change in KOOS Pain and Function (SRA) Scores in the 2-Year Study

	MACI Mean (SD)			Microfracture Mean (SD)		
	N	Pain	Function	N	Pain	Function
Baseline	72	37.0 (13.5)	14.9 (14.7)	71	35.4 (12.1)	12.6 (16.7)
Week 104	72	82.4 (16.2)	60.9 (27.8)	70	70.9 (24.2)	48.7 (30.3)
Change From Baseline to Week 104	72	45.4 (21.1)	46.0 (28.4)	69	35.2 (23.9)	35.8 (31.6)
LS Means (Week 104)		44.1	46.1		32.4	34.6
Difference * [MACI – Microfracture]		11.8	11.4			
p-value **		0.001				

LS = least squares; KOOS = Knee injury and Osteoarthritis Outcome Score; SD = standard deviation; SRA = Sports and Recreational Activities.

* Difference in least squares mean values at Week 104 [MACI – Microfracture].

**p-value for difference in co-primary endpoints assessed jointly at Week 104 based on multivariate analysis of variance.

In a responder analysis, the proportion of subjects with at least a 10-point improvement in both KOOS pain and function (SRA) was greater in the MACI group (63/72=87.5%; 95% CI [77.6%, 94.1%]) compared with the microfracture group (49/72=68.1%; 95% CI [56.0%, 78.6%]).

All subjects from the 2-year study had the option to enroll in a 3 year follow-up study (extension study), in which 128 subjects participated. All 65 subjects (100%, 65/65) in the MACI group and 59 subjects (93.7%, 59/63) in the microfracture group completed the extension study. The mean 2-year KOOS pain and function scores remained stable for the additional 3-year period in both treatment groups (Table 4).

Table 4. KOOS Pain and Function (SRA) Scores in the 3-Year Extension Study

Visit	MACI			Microfracture		
	N	Pain mean (SD)	Function mean (SD)	N	Pain mean (SD)	Function mean (SD)
Baseline	65/65	37.1 (13.1)	15.4 (14.8)	63/63	35.2 (12.3)	11.9 (16.2)
2 Years	63/63	82.2 (15.8)	60.5 (26.5)	60/60	71.8 (23.9)	48.9 (30.6)
5 Years	65/64	82.2 (20.1)	61.9 (30.9)	59/59	74.8 (21.7)	50.3 (32.3)

15 REFERENCES

1. Saris D, Price A, Widuchowski W, Bertrand-Marchand M, Caron J, Drogset JO, et al. Matrix-applied characterized autologous cultured chondrocytes versus microfracture: two-year follow-up of a prospective randomized trial. Am J Sports Med. 2014 Jun;42(6):1384-94.
2. Roos EM, Lohmander LS. The Knee injury and Osteoarthritis Outcome Score (KOOS): from joint injury to osteoarthritis. Health Qual Life Outcomes. 2003;1:64.

16 HOW SUPPLIED/STORAGE AND HANDLING

How Supplied

- A single patient order may contain 1 or 2 implants, each in its own dish and shipper, depending on lesion size and number of lesions.
- MACI, NDC69866-1030-1, contains 1 implant supplied ready for use as a single cellular sheet approximately 3 x 5 cm, in a sterile, sealed, clear polystyrene dish. Each dish contains one 3 x 5 cm implant with a 0.5-cm² section removed from the lower left hand corner, held in place by a polycarbonate 5-pronged ring closed with a polycarbonate cover for shipment.
- MACI, NDC69866-1030-2, contains 2 implants supplied ready for use as cellular sheets approximately 3 x 5 cm, in a sterile, sealed, clear polystyrene dish. Each dish contains one 3 x 5 cm implant with a 0.5 cm² section removed from the lower left hand corner, held in place by a polycarbonate 5 pronged ring closed with a polycarbonate cover for shipment.
- Each dish is individually sealed in a clear plastic bag. The plastic bag(s) are placed into one 95kPa pouch (outer bag) with absorbent material. This pouch is enclosed in an outer carton insulated with ambient temperature gel packs.
- MACI is shipped cell-side up.

Storage and Handling

- Store MACI at room temperature in its original packaging (outer carton) until ready to use.
- DO NOT REFRIGERATE or FREEZE, or sterilize MACI.
- Do not use if the dish is damaged or has been compromised.
- Use MACI prior to 11:59 PM ET on the date of expiration printed on the package.
- Dispose of unused MACI or waste material as surgical biohazardous waste in accordance with local requirements.

17 PATIENT COUNSELING INFORMATION

- Advise the patient that:

- A cartilage biopsy is needed to manufacture MACI. The biopsy is typically performed as an arthroscopic procedure at the time of diagnosis confirmation.
- The length of time between the biopsy and the implantation of MACI may vary depending on many factors, including the quality and number of cells obtained from the biopsy. On average this will take 6 weeks; however, cells can be held in storage until a convenient date for surgery is agreed upon between the patient and the surgeon.
- Even if the surgeon has taken a biopsy needed to produce MACI, it may be possible that the patient cannot be treated with MACI, (e.g., in case the biopsy is of insufficient quality to produce MACI, if the cells cannot be grown in the laboratory, or if the expanded cells do not meet all the quality requirements).
- Advise the patient on the risk of graft complications, subsequent surgical procedures, and treatment failure. [*See Adverse Reaction (6)*]
- Advise the patient on general complications related to knee surgery, which may include deep vein thrombosis and pulmonary embolism.
- Advise the patient to closely follow the physician-prescribed rehabilitation program, which will include limitations and allowances for beginning specific physical activities. [*See Dosage and Administration (2.3)*]

Manufactured by: Vericel Corporation, 64 Sidney Street, Cambridge, MA 02139

MACI[®] is a registered trademark of Vericel Corporation.

© 2016 Vericel Corporation.

65617.A